

调心球轴承

d 95-150mm-2219-K-M-C3

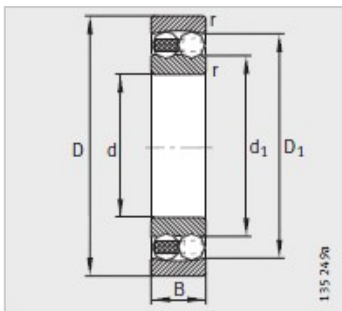

型号 :	2219-K-M-C3
质量m kg :	4.24
尺寸 mm :	
d :	95
D :	170
B :	43
rmin :	2.1
D :	148.6
d :	118.9
C :	-
安装尺寸 mm :	
dmin :	107
D max :	158
rmax :	2.1
基本额定载荷 N :	
动载荷 :	84000
静载荷 :	34000
计算系数 :	
e :	0.27
Y :	2.32
Y :	3.59
Y :	2.43
疲劳极限载荷Cur/ N :	1840
极限转速 nG /min - 1 :	6000
参考转速nB/min - 1 :	5600

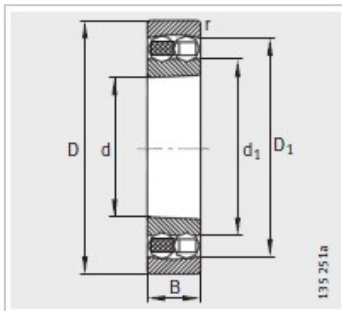
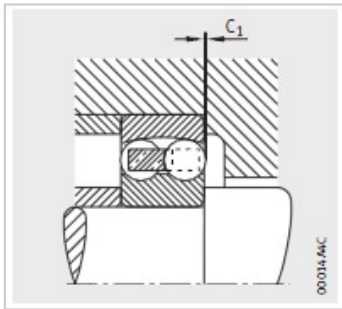
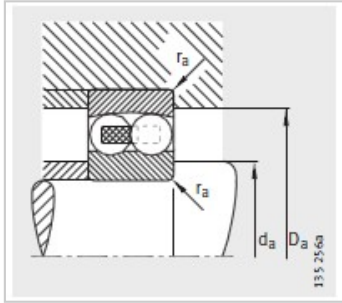