

调心球轴承

d 95-150mm-1220-K-M-C3

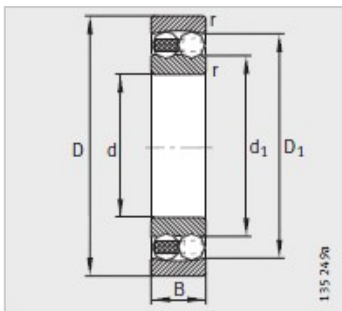

型号 :	1220-K-M-C3
质量m kg :	3.94
尺寸 mm :	
d :	100
D :	180
B :	34
rmin :	2.1
D :	155.2
d :	127.7
C :	-
安装尺寸 mm :	
dmin :	112
D max :	168
rmax :	2.1
基本额定载荷 N :	
动载荷 :	70000
静载荷 :	29500
计算系数 :	
e :	0.18
Y :	3.58
Y :	5.53
Y :	3.75
疲劳极限载荷Cur/ N :	1550
极限转速 nG /min - 1 :	5600
参考转速nB/min - 1 :	6100

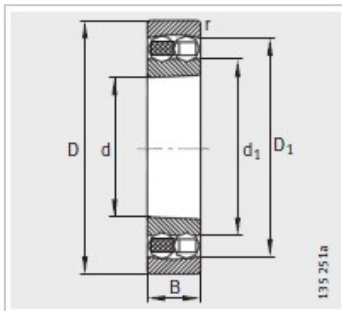
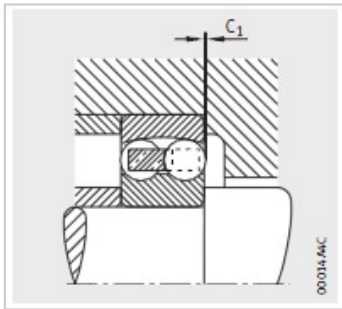
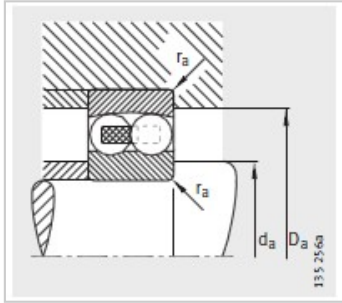